

Information Display Design: A Survey of Visual Display Formats

William B.L. Wong¹
Department of Information Science
University of Otago

July 1994

Abstract

This paper reviews the research and practice of how computer-based output information has been presented in nine different information display formats and the suitability of their use in environments ranging from static, reference-type situations, to complex, dynamic situations. The review while not generating conclusive results suggests that displays are more than a platform to place information. Instead care should be taken to organise, lay out, and pre-process the information so that it enhances the communication between computer and human. The information on the screen should also be designed to augment human cognitive limitations. For instance, human weakness in integrating information across time and multiple sources could be assisted by display formats that integrate the information in the display rather than having the user attempt to integrate that information mentally. If this be the desired outcome, information designers must start to consider performing analyses that help them understand the demands on the human information processing system and hence how information can be presented to augment this weakness. This would have to be further investigated in subsequent research.

Keywords: information display design, output information, visual display formats

¹ Address correspondence to: William B.L. Wong, Lecturer, Department of Information Science, University of Otago, P.O. Box 56, Dunedin, New Zealand. Fax: +64 3 479 8311 Email: wwong@commerce.otago.ac.nz

1 Introduction

To enable the user to work with a computer, the human-computer interface can be said to provide a user with three types of information. The first type of information provides the user cues for manipulating the controls of the interface, e.g. “Press <esc> to exit”, the menu bar; the second type provides the user with feedback about their actions, e.g. “Save changes before closing?”, the clock cursor to show the system is responding. These two types of information refer to the interaction techniques for operating the interface. The third type of information provides the user with the necessary output information to perform a particular task (ACM SIGCHI Curriculum Development Group, 1992, p23), for example, a list of names, departments, and telephone numbers is required by the university’s telephone operators to connect incoming calls to the appropriate person. This paper will address the third type of information, and will in particular, review the various forms in which computer output information can be presented to a user, their suitability in conveying computer-based information, and an overview of the research focus in each area. Before addressing the review, we will need to understand the benefits that appropriately formatted output information can provide users and their organisations.

2 Why Format Output Information?

Venturino and Post (1992) write that the purpose of a display is to “... provide a coherent representation and *effective communication* of task-critical information from an environment...” (p509). In other words, the display must not only provide the right information for the task, but also have the information formatted appropriately so that the relationships between the displayed data elements are clear and obvious (NAA, 1971). Information that is well organised so that the meaning is “... intuitive, precise and unambiguous” (Rateman, 1993) will serve to make the information “readily accessible” to the viewer (Garland, 1992). If computer-output information is appropriately organised and presented, human performance can be expected to improve in terms of taking less time and effort to locate, read and interpret the information. On this premise, two independent empirical studies - Tullis (1990), and Bednall (1992) - were conducted which resulted in significant monetary savings for the organisations concerned. These studies are briefly reported below.

Tullis (1990) reported how an information display of Bell’s Automated Repair Service Bureau system was re-designed to reduce clutter, and improve the visual and logical

organisation of the displayed information elements. Tullis based his re-design on four empirically derived characteristics of good screen design. They are:

- a. overall density: the number of characters displayed, expressed as a percentage of the total spaces available;
- b. local density: the average number of characters in a five degree visual angle around each character;
- c. grouping: the extent to which characters on the display form well defined perceptual groups;
- d. layout complexity: the extent to which the arrangement of items on the display follow a predictable visual pattern.

The re-designed screen resulted in a 3.3 second savings in the time to locate diagnostic information on the screen. This saving equated to a 79 person-year saving or a 40% reduction in usage time over a year of system use.

Bednall (1992) studied the displays of the Electronic White Pages, an electronic directory of customers' names, addresses, and telephone numbers, of Australia Telecom. She studied the effect of varying the display density, i.e. the amount of information displayed on a screen at any one time, and display organisation, on task performance of the telephone operators. Her studies concluded that search times improved by as much as 10% simply by not displaying redundant surnames, and inserting blank lines at appropriate places.

The conclusions from both studies indicate that there is value in designing how output information is presented to the operator, and in the cited cases, the benefit is in improvements in visual search performance. Scott (1993) provides an extensive review of the visual search literature which also suggest other benefits from improved search. Besides being able to locate desired information quickly, other benefits of good display design include how visual clarity enhances the readability and message understandability of displays by revealing the relationship between displayed items, accuracy and recall, integration and visualisation of a large amount of information and from multiple sources, and speed of detecting systemic anomalies or changes. This paper will examine 9 information display formats from a variety of task environments, and examine how these benefits were obtained.

3 Narrative Displays

Narrative displays present alphanumeric information in the form of prose or plain English, where the user would usually read the display from left to right. This is one of

the most flexible forms of display. Almost anything can be encoded in narrative displays. It is however, slow to read and interpret. It is best suited to static-type displays where the information does not change or changes only infrequently.

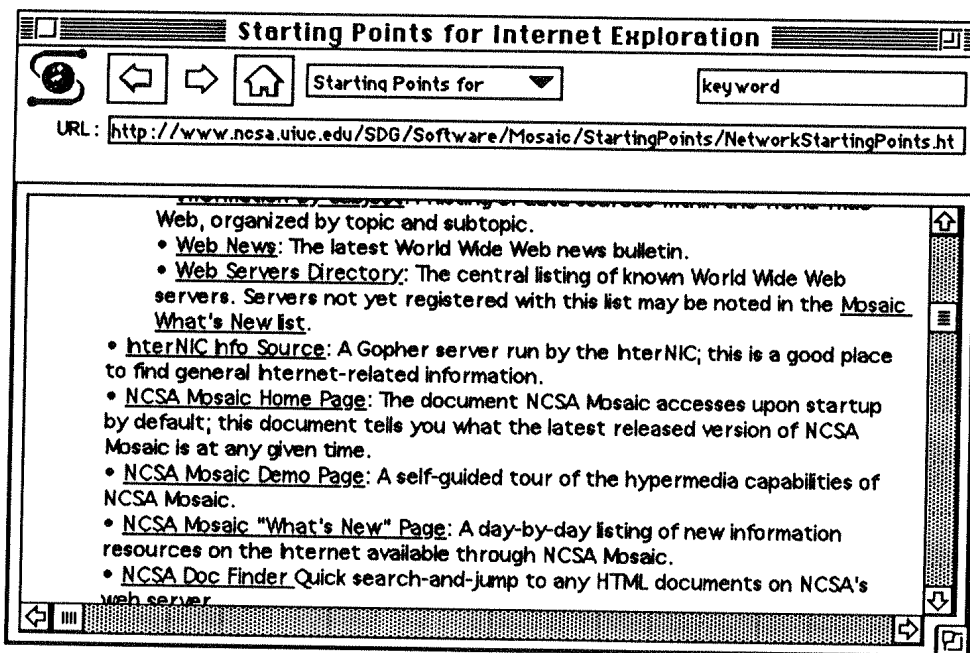

Figure 1: The display window of the MOSAIC user interface shows a narrative display format.

The display area of the window shown in Figure 1 is an example of a narrative display. This window is the interface of MOSAIC, the hypertext tool for navigating the World Wide Web. By <clicking> on the underlined words, MOSAIC connects the user to the node, and displays more narrative-type information about that topic.

The work in designing narrative displays is referred to as information design (Orna and Stevens 1991, Wright 1988), and draws on the traditions and cumulative knowledge of typographers and graphic artists bridging the gap between paper and electronic media. The objective of information design is to use page layout, and other visual and conceptual methods for ordering textual information "... to make ideas visible..." (Orna and Stevens, p 197) and to aesthetically communicate the meaning of the written word. The authors cite commonly heard comments from computer programmers defending their designs, "Well, if the user looks hard enough, he'll find the information!", and "... he'll get used to it!"; and argues that content is as important as form as poor design only serves to compound the users' problems, and defeats the objective of using screens to enhance communication.

Dillon (1992) provides an exhaustive review of the research comparing reading from screens and reading from paper. One of his conclusions indicates that although the evidence is not conclusive, there is significant justification to believe that people generally read more slowly from screens than from paper. This general finding translates into a design guideline that the amount of text presented on the screen should be minimised.

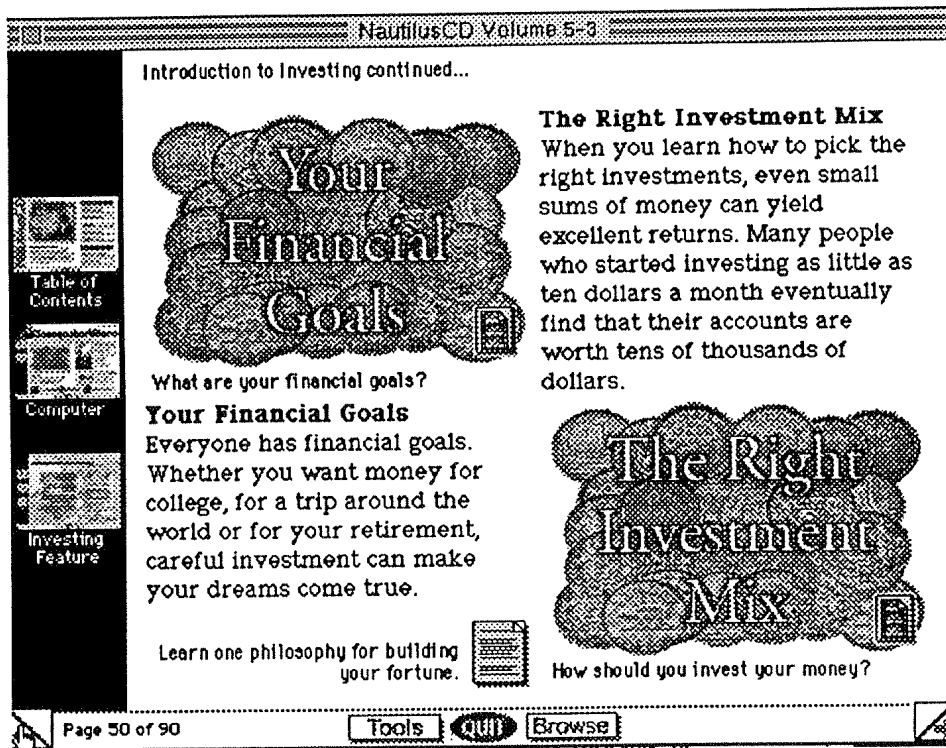

Figure 2: Narrative text occupies 50–60% of total display space available. Details and explanations are communicated through animation, sound, pictures, or more details that are software based by selecting one of the following icons respectively:



In commercial applications like Metatec’s *Nautilus CD* a multimedia monthly electronic magazine, the textual component of the screen presentation is about 50 - 60% of overall display density. The text serves as a framework on which sound, animation, and pictures, are attached to provide further explanation to a topic. Figure 2 is a sample screen of the feature article on personal financial investments from the March 1994 issue.

Guidelines for narrative-text formats have been modified from guidelines for typography of the printed page. Horton (1991), Horton (1990), Girill (1991), Carliner (1990), Harris (1990), provide extensive sets of guidelines for the layout of narrative-style text, and include use of indentation and highlighted headings to represent the

structure of the information. Blattner and Dannenberg (1992) present a collection of articles that guides designers on the integration of sight and sound to enhance the effectiveness of multi-modal and multimedia computer-to-human communication. This paper will however, refrain from addressing the issues of multimedia interface design.

4 Lists and Tables

Lists and tables present information organised in a row and column format to support the task of searching and selecting target information, to show relationships between x and y values, or simply displaying listings of each occurrence. This type of display usually presents precise or exact numeric information or text summaries in a table or list e.g. a spreadsheet-type display, a stock exchange display of share prices, a listing of telephone subscribers, or flat vacancies as displayed in Figure 3.

Address of flat	Contact name	Contact phone	Vacancies	Smokers?	No of beds
21 George Street	Mary	477 8933	2	No	
6 Union Street	Bert CHALLIS	477 1196 home 479 8373 work	1	OK	
36 Carlyle Street	Mamie OBERER	473 7502	1	OK	
22 Woodhaugh Street, Leith Valley	Maureen BELL	467 9126 or leave a message on 477 3811	4	No	
144 Leith Street	Maree, Rachel, Matthew		1	OK	
30 Dundas Street	Dave and Mark	477 2897	2 Females	No	
Flat 7, 69 Queen Street	Kevin or Ash	477 1579	2 Females	No	
699a Cumberland Street	Yanessa	479 2849	2	No	
636C Great King Street	Karen & Chi Wing	479 2968	2	No	
87 Harrow Street	Andrew or Paul	Call at flat	1 Female preferred	No	2
79 Oxford Street, South Dunedin	Tania CAMERON	455 6288	2	No	
699 Cumberland Street	Teresa or Gurlen	477 1308	3	No	
8B Pkt Street	Marcus or Yanessa	477 2117	3	OK-if	

Figure 3: Tabular listing of flat vacancies held at a typical accommodation agency (fictitious data)

Smith and Mosier (1986) document at least 15 guidelines for the display of tabular data, distilled from an extensive literature review. The list include guidelines to display reference items in the left column, and less significant information to the right; order items vertically in multi-column lists rather than across; adopt a hierarchic structure for displaying long lists. Examples of research in this area include visual search

optimisation (Bednall, 1992) and comparisons between the relative efficacy of displaying numeric data in table format and as graphs (Coll et al, 1994, Coll and Coll, 1993).

5 Fill-in Forms

Although fill-in forms are principally used for the capture or input of data into a computer, they are not restricted to it. In many systems, fill-in forms are also used to display required task-oriented output information in an interactive manner. Galitz (1993) refers to such data-entry and inquiry display screens as multi-purpose screens, and provides an extensive set of display design guidelines which include guidelines for the structure, size and formatting of captions or field labels; entry fields; alignment; keying order; and spacing to balance the display. The design goal is "... to provide optimum visual clarity and to represent the organisation of the world from which the data is collected" (p 162). We will now examine a particular instance of such a screen.

```

1 FDX          3:49          3- 16
-----
incident no: 6A1509  status: A  level: 3  start time 15:49:26  19/08/93
dist: 6A01 DUNEDIN CITY  zone: 6A2133  dist. mc.: 981
alarm method: 111  incident type: STR / 143
pfa no: 1515  alarm type: SENTINEL AUTO  key: 132
building/rural no: THE BLUE PALMS HOTEL
street: 229 / HIGH STREET 0 - 204
suburd: DUNEDIN CITY
intersection:
info:
directions :
locn text  :
crit. info :

pumps pumps rescue aerial other first alarm second alarm
D212          D215 D2114 4*P* 1CU 2*P*
S221          1TL
W257
R241          third alarm fourth alarm
P237          tankers officers addit 2*P* 2*P*
R281
P271

locn: dir: crit: fuel: la:DCC wtr: risk: N
tact: D33 gen: frst: haz: fa:NZFS map: J10-7
conts: Day 03-477-0987 pfa: BENEFIS

```

Figure 4: A Fill-in Form Display (source: NZ Fire Service Computer Assisted Dispatch System)

Figure 4 shows an example of a partially completed fill-in form used by the New Zealand Fire Service dispatchers. The system use this screen for the display of both

input and output information. The screens display green characters against a black background.

The dispatcher would type in location and severity of a fire, then on the same form, the system would respond with a list of the nearest available fire appliances (pumps) to the fire site. This is displayed in the lower left half of the screen. The lower right half of the screen displays the standard number of appliances needed for a particular type of fire and according to severity as indicated by the headings “first alarm”, “second alarm” and so on. The type of fire in this example was keyed in under ‘incident type’ in the input section as “STR” or a structural fire.

The use of fill-in forms to display output information simultaneously decreases the number of different windows an operator has to interact with, and gives the user an overview of all the necessary working information at one glance rather than having to access separate sub-screens for the information. Frey and his colleagues reported that user performance decreased as the number of sub-screens of job-required information increased (Frey et al 1992).

However, displaying all information at the same time, whether it is required at that moment or not, has the disadvantage of occupying more screen display space and making the display look cluttered. This could cause reductions in visual search performance. However, this may be preferred in situations where the system response time to display sub-screens of required information may be more than the extra time needed to search through the more dense display. The above display has another shortcoming. It lacks visual cues to indicate the relationship between the information elements. Are Pumps D212, D215 (comes with an aerial ladder), and D2114, part of the first alarm requirements? It would seem so if one were to read as one would normally from left to right, the lower half output area of the display. Logically related information should be grouped so that the groups are visually distinct with cues as to how that group of information should be read, related and interpreted.

6 Data graphics

Data graphics refer to numeric data that is presented as bar charts, trend (fever) charts, pie charts and band charts. These charts are useful for presenting single-dimension quantities, trends, proportions and proportions over time. Current computer capabilities make the beautifying of such graphs, like giving them an illusion of 3-dimensional depth, an easy matter.

The upper three charts in Figure 5 show simple, non-embellished graphs. The lower three charts are examples of embellishment using the pseudo 3-dimensional effect. With modern computer software, to enhance graphs with 3-dimensional effects, a user simply selects the desired type of effect from a menu, and the computer computes and displays the desired visual effect.

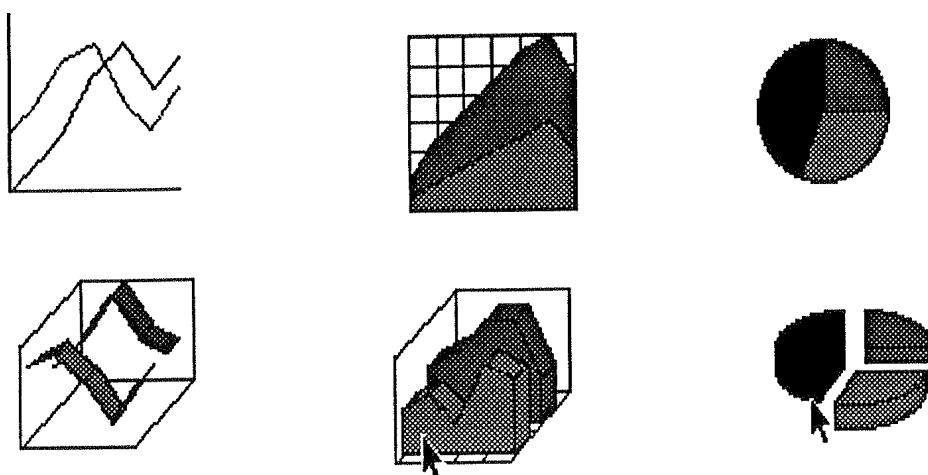

Figure 5: Are embellished data graphs more informative?
 (Source: gallery menu, Microsoft Excel)

Tufte (1983) has however advised against such beautifying practices as they do not provide the viewer with more information, and instead result in what Tufte calls decreasing the “the data : ink ratio”. Ideally, one should use only as much ink as necessary to represent the message contained in the data represented by the chart. Furthermore, the embellishments can result in inaccuracies in reading data from the graphs. Carswell has found in a series of studies (Carswell 1991, Carswell et al 1991, Carswell 1992) that embellishing data is detrimental, and in her experiments embellishing data led to reduced accuracy and poorer recall.

Another aspect of data graphics is deciding which chart is an appropriate vehicle for communicating the desired message. Zelazny identifies five kinds of comparisons that would be ideally supported by appropriately graphing data: component comparison, i.e. the size of x as a percentage of the total, what is the share of x ; item comparison, i.e. the ranking of items, for instance whether x is larger than y ; time series comparison are useful in showing changes over time; frequency distribution comparisons are used to show how many items fall into a series of ranges; correlation comparisons helps identify relationships between variables, e.g. x increase as y increases. Zelazny then recommends the type of basic chart – pie charts, bar charts,

column charts, line charts, and scatter charts – that is appropriate for the particular comparison task.

7 Maps and Data Graphics

Data graphics are sometimes more effectively used in communicating the disposition of the actual phenomena measured by laying out the data graphics on a map of some sort to correspond with the location of their occurrence, for example, population densities visually presented on a map of a geographical area. Southby and Ezigbalike (1993), provide a good survey of the various methods of spatially displaying statistical information. The techniques documented to represent the occurrence of an event or feature as it relates to a geographical region include the use of repeated symbols, proportional circles, and dot maps to show density of occurrence; repeated statistical diagrams to show the nature of distributions among regions; chloropleth maps which show variations between regions and isopleth maps which connect areas with similar characteristics; and flow lines to show which routes are most heavily used. The value of such data display techniques lies in their ability to visually match the occurrence of an event or an entity to its physical location represented by the map, thereby reducing mental effort to visualise the relationship. In this manner the information from the different sources – the statistical information and the spatial frame of reference – have been integrated for the user. In *Envisioning Information*, Tufte (1990) provides an excellent collection and classification of the various ways information designers can effectively represent spatially-based information in 2-dimensional space.

8 Electronic Mapping

Another application of spatially-portrayed information includes the long-time use of maps by the military to show troop deployments and areas of operations. From experience, military commanders almost always prefer to view the operational situation with theirs and the enemy's troops, ships, or aircraft, indicated on a map than to have each troop location presented in a table of map grid reference points. Figure 6 shows a sample screen from such a system which uses standard military nomenclature to indicate own and enemy unit positions, area of operations and military objectives, and even boundaries for fire support co-ordination. A topological map may be overlaid to give the viewer a better appreciation of the context of the information (Command System, Inc., 1992).

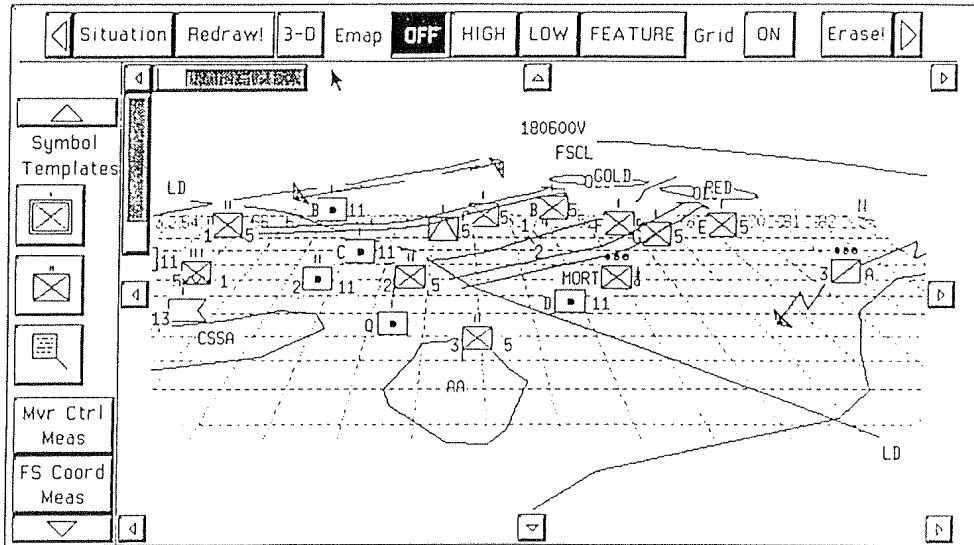

Figure 6: Sample map-based screen of COMMAND OPERATIONS Support System

Geiselman et al (1986) studied how typical tactical map clutter may be reduced by using computer-based overlays to present and integrate additional information about the tactical situation in the battlefield to field commanders. Geiselman and his colleagues also studied the cognitive processes that took place during the evaluation of the tactical map displays, and concluded that the guidelines for integrating the information in the electronic map overlays must be congruent with the goals of the task being performed. Aretz (1991) used cognitive task analysis to investigate the efficacy of pilot-centered electronic navigational map displays and world-centered displays. Aretz concluded that the orientation of electronic cockpit map displays will be determined by the goals of the navigation task being performed. A pilot centered display better serves a navigation task, while a north-up aligned display better serves world referenced tasks like reconnaissance flights. Repede et al (1993) examined how electronic maps may be used to facilitate the task of optimising ambulance deployment in the City of London. The map displays provide an interface to a sophisticated mathematical model to support the decision of assigning the closest ambulance to the incident site. The success of these studies appears to be associated with the researcher appreciating the cognitive limits of the users and providing a means of overcoming that limitation. For example, since one well-established human cognitive limitation is our poor ability to integrate information from many different sources (see Wickens, 1992, for detailed review), Geiselman and his colleagues devised a system to integrate multiple sources of information for the

planner by allowing the planner to selectively call up overlays which contained different aspects of the tactical situation.

9 Object Displays and Emergent Features

Object displays refer to the use of shapes and perceived patterns to monitor and display key actual or computed measures of performance of complex dynamic systems or processes. For example, the key indices of performance of, say, a refinery process are pre-calculated such that the data is graphically represented as three column charts with the tallest column chart to the left and the shortest on the right as shown in Figure 7 A.

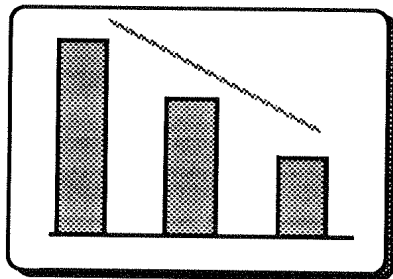

A: Emergent feature left to right descending tops under normal conditions (Sanderson et al 1992)

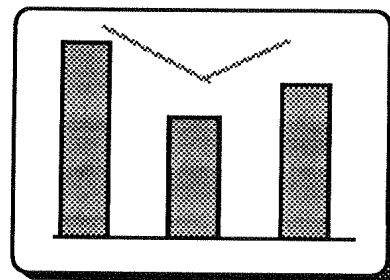

B: Change in emergent feature easily perceived once the normal conditions exceeded (adapted from Sanderson et al 1992).

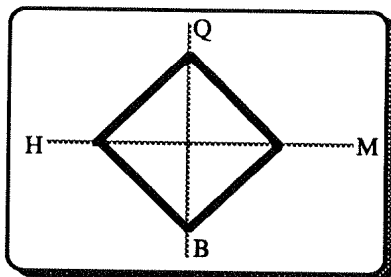

C: Under normal conditions, the emergent feature is a square, integrating the performance of 4 variables Q, M, B and H (based on Coury and Boulette, 1992).

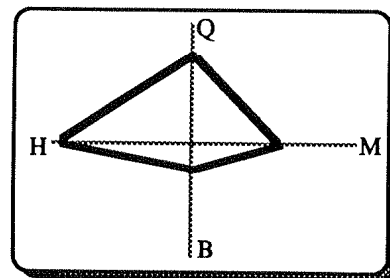

D: Emergent feature changes, under warning or danger conditions (based on Coury and Boulette, 1992)

Figure 7: Emergent features displays make it easier to detect system abnormalities

Performance is monitored in real-time, hence the displays are updated dynamically. Under normal operating conditions, by visually lining up the tops from left to right, a left to right sloping line *emerges*. This resulting sloping line or *feature* of the display is termed the *emergent feature* (Bennet et al. 1993, Buttigieg et al. 1991). The display will indicate anomalies or danger if the emergent feature starts to change its shape beyond set tolerances, e.g. the sloping line starts to form a kink or elbow as shown in Figure 7 B. In the event that all the variables increase or decrease at the same rate, i.e.

maintaining the integrity of the emergent feature but the whole system increasing or decreasing out of the tolerable limits, bands showing the acceptable limits of performance could be superimposed over the display to assist the operator to detect abnormal conditions.

Object displays or emergent feature displays are principally intended for use in depicting the system state of complex dynamic processes where system states are constantly changing and where detection and interpretation over time is important (Sanderson et al 1992), for example, chemical process control, nuclear power plants. The key problem of monitoring such systems is the huge mental task of monitoring and mentally *integrating* numerous dimensions of system status data and to draw conclusions about whether the system is within acceptable performance ranges. Using emergent features to integrate and display critical system performance measures as a visually recognisable object can assist in reducing operator load and increase detection accuracy. Patterns stretching beyond pre-defined “everything is OK” limits will highlight abnormalities and alert the operator.

10 Mimic Displays

A mimic display is a stylised symbolic or pictorial representation of a system with displayed data associated with pertinent system elements. The display of a computer network’s operational status in a pictorial format is an example of a mimic display. It can portray availability of links and nodes or breaks in the network, and may even display traffic loads and other performance information. It should be noted that mimic displays should not be crowded with details, and that the general relationship between physical components be preserved as much as possible on the display. This would facilitate the location of physical faults in the system.

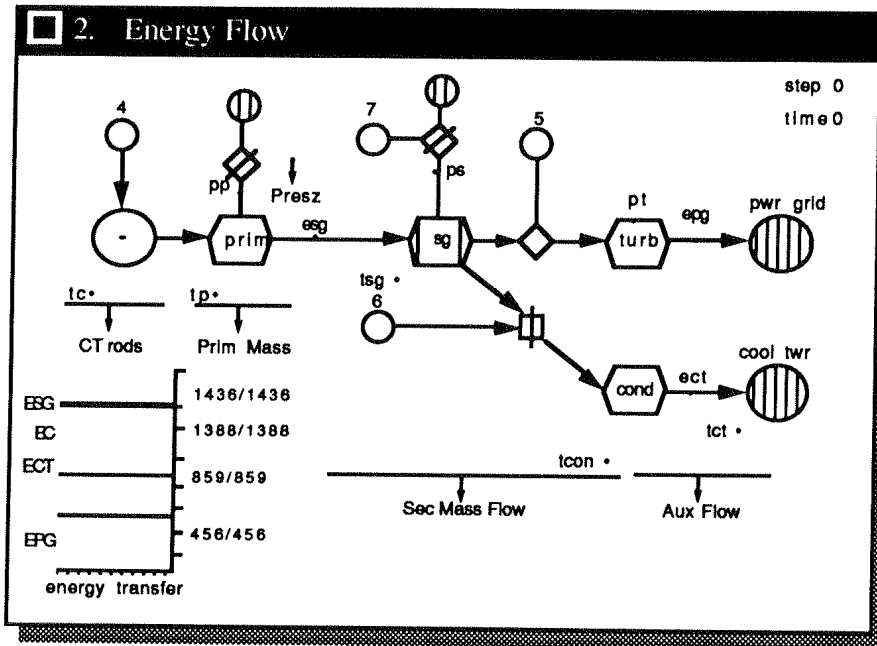

Figure 8: A mimic display showing flows in one process of a simulated nuclear power plant (Praetorius and Duncan 1991)

Praetorius and Duncan (1991) studied how mimic displays, or flow representations, help operators diagnose problems in the flow processes by helping them trace the origin of faults so that appropriate corrective actions may be initiated; and because in process flow systems different faults can generate similar and hence confusable symptoms, the display allowed the operator to test various hypotheses to see which control loop is at fault, rather than to rely on human judgement. Figure 8 shows a mimic or process flow display from the simulated nuclear generator.

11 Visualisation of Large Information Spaces

The purpose of the display design of this category of visual displays is to provide the user with an overview of the contents of a large amount of information without losing sight of the relationships between the displayed pieces of information. TreeMaps (Turo and Johnson 1992), is a visualization technique that iteratively “slices and dices” hierarchical information and displays the information as rectangular tiles on the computer display. Each tile represents an entity or node of the hierarchical information structure, while the size of the tile represents the magnitude of the particular dimension of interest. Jungmeister and Turo (1992) applied TreeMaps to stock portfolio management. While each tile represents a stock in the manager’s portfolio, in one instance, the size of the tile was used to represent the difference between purchase price and current prices, and the direction of the change indicated by colour; and in another the size represented market activity or volume of transaction. The largest tiles would

attract the greatest attention, thereby assisting in directing attention to the stocks of greatest significance. Figure 9 shows the TreeMap as applied to stock portfolio management.

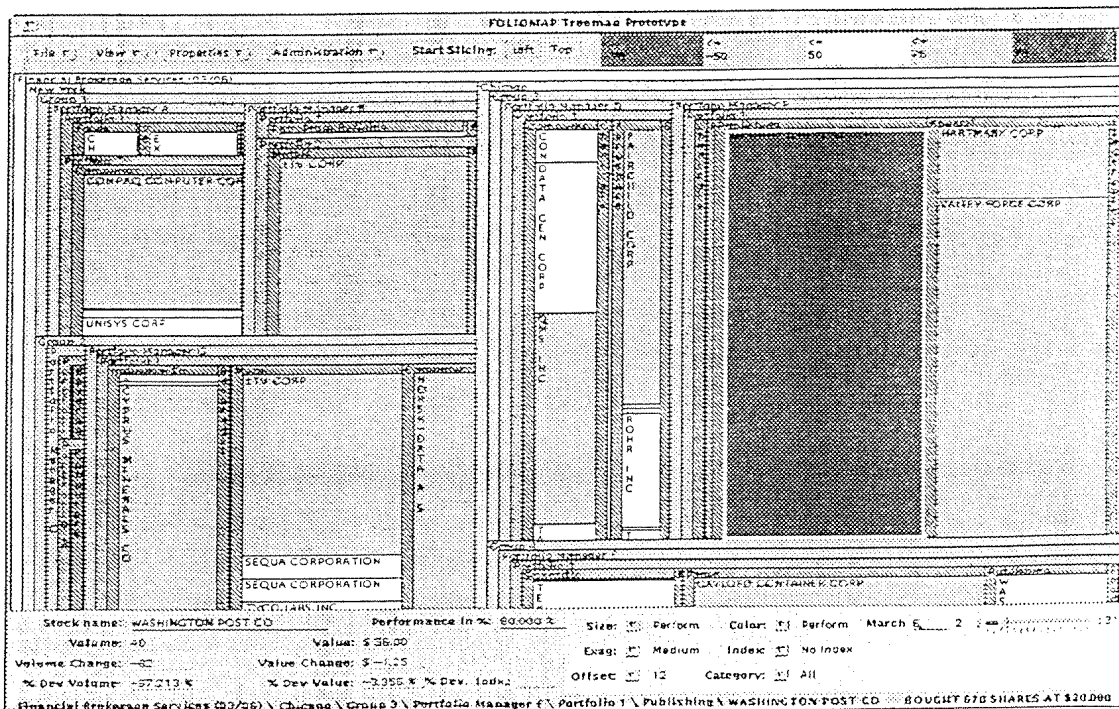

Figure 9: TreeMap applied to stock portfolio management

Other approaches to the visualization of large information spaces include the Perspective Wall (Mackinlay, et al, 1991), the Information Visualizer (Card, et al, 1991), and Cone Trees (Robertson, 1991).

12 Colour

While colour is not a visual information display format, it provides another dimension in which to add more information and to enhance a user's ability to use the information displayed. Colour when used according to established guidelines (Horton 1991) can increase the rate at which information is extracted from charts (Hoadley, 1990), and improve decision making in time constrained situations (Benbasat and Dexter, 1986). Of the many functions which colour serves, this paper will address three of what this author regards as the more important: to increase the information density of a display, to direct attention, and to discriminate information.

12.1 Increasing Information Density:

When used judiciously colour can increase the information density of a display by encoding additional messages into it. For example (see colour plate), in the Ambulance Summary Status Screen of the St John's

Ambulance Computer Assisted Dispatch System, the information is heavily colour coded. If the displayed radio call sign "10" of ambulance 'Dunedin 10' is displayed as white characters on a red background, it indicates that the ambulance is two crewed and one of the crew is a paramedic; if it is displayed as white characters on black, it simply represents a standard two-crew ambulance; however if it is white on brown, the ambulance is a one-person operation. More information is encoded into fewer separate screen items than if no colour was used.

The advantage of this colour coding is that it saves screen display space, instead of having additional columns to indicate these crew and qualification status of the ambulance. There are disadvantages, and one that immediately comes to mind is that there are more codes to remember, i.e. for the novice or new operator, the cognitive load is increased with the corresponding increased potential for mistakes. However, that should not be a major problem as it is not expected that untrained novices operate the system. Furthermore, the colour coding has been made associative with real-world entities; for example, the paramedic qualification arm badge worn by the paramedic has a white design on a red background, just as how this information is encoded in the dispatch system's display.

12.2 Directing attention:

Another use of colour is for bringing important information to an operator's immediate attention. For example, the entire computer display line containing information about an aircraft being controlled by an air traffic controller could turn red to alert the controller that the aircraft is overdue at a given destination. Search and rescue could then be initiated.

12.3 Discriminating Information:

Colour could also be used to assist users in discriminating between relevant and irrelevant information. Fever charts or line graphs showing the performance of a set of stocks could be colour coded so that the line graph of the best performing stock is in one colour, the worst in a contrasting colour, and the mediocre stocks in a neutral colour; alternatively, one could colour code a specific stock to monitor so as to reduce visual search time to locate its line graph.

12.4 The monochromatic trade-off:

In monochromatic displays any additional information will need to be encoded separately, for example, additional data items will be needed to represent and display the number and qualification of the ambulance crews in the St John's Ambulance Dispatch System cited above. More screen display space is required to display these extra items. There is no clear advantage in this because the operator must still remember what the [say] one character code represents. In terms of drawing attention, one can highlight important information using 'reverse video', or by using blinking to indicate a higher level of urgency. In spatial visualisation or electronic

mapping, colour is indispensable because of its ability to reduce the clutter that would otherwise occur when using monochromatic screens. A monochromatic electronic map display would require hatch patterns in order to indicate different areas in the map display, e.g. areas bounded by contour lines. Inappropriate use of hatchings or shading patterns can lead to an uncomfortable visual sensation that feels like the display is vibrating. This is known as the Moire effect.

13 Conclusion

Although this report does not address all the different types of displays that populate the world, the different information display formats examined are indicative of the diversity of the many task environments in which computer displayed information is used. Several general observations about designing information displays can be drawn from the review, and they also suggest ideas that need further investigation. They are:

- a. Different and innovative forms of presentation have been devised to cater to the demands placed on the human operator working in the various task environments. In designing information displays, the designer should consider the cognitive characteristics of the task environment and attempt to design information displays that capitalise on the computer's strengths and augment the human operators' limitations in their ability to integrate information over time and from multiple sources.
- b. Information should not be presented haphazardly or at the whim of the system designer in the belief that the user will eventually get used to the display; rather, the cognitive processing requirements of the task should be closely examined so that the information displays would present information in such a manner that it closely corresponds to the cognitive goals of the task.
- c. The function of information displays is not just to display information, but to enhance the communication between computer and the person using the system. Enhanced display design effectiveness can improve visual search speeds, display readability and ease of message understanding, integration of information from multiple sources, visualisation of large data sets, and can speed up the detection of systemic anomalies or changes. All these can result in fewer mistakes and improve performance.
- d. The displays discussed in this review appear to exhibit some attributes that could be loosely classified according to a scale of how dynamic and time-pressured the task environment is. Narrative, data-graphics, and electronic mapping type displays are more likely to be applied to task environments that do not change much within a short span of time, while object and mimic

displays are more likely to be found at the dynamic end of the spectrum. This will need further investigation.

- e. Colour should not be viewed as an optional dimension in information display design. The use of colour to gain the benefits of increased information density, improved perceptual discrimination and directing of attention must be considered early in the information display design process.

Acknowledgements

I would like to thank Prof. Philip Sallis, Drs Steve MacDonell, George Benwell, Albert Yeap, and Mr Martin Anderson, and the anonymous reviewer, for their many helpful comments and ideas, some of which have found their way into this paper.

References

- ACM SIGCHI Curriculum Development Group, *ACM SIGCHI Curricula for Human-Computer Interaction*, ACM Inc.: NY, 1992
- Aretz, Anthony J., "Design of Electronic Map Displays", *Human Factors*, 1991, Vol. 33, No. 1, p 85 - 101.
- Bednall, Elizabeth S., "The effect of screen format on visual list search", *Ergonomics*, 1992, Vol. 35, No. 4, p 369 - 383.
- Benbasat, Izak, and Dexter, Albert S., "An investigation of the effectiveness of colour and graphical information presentation under varying time constraints", *MIS Quarterly*, March 1986, p 59 - 79.
- Bennett, Kevin B., Toms, Mona L., Woods, David D., "Emergent features and graphical elements: Designing more effective configural displays", *Human Factors*, 1993, Vol. 35, No. 1, p 71 - 97,
- Blattner, Meera M., and Dannenberg, Roger B., (eds.) *Multimedia Interface Design*, Frontier Series, ACM Press: NY, 1992.
- Buttigieg, Mary Anne, and Sanderson, Penelope M., "Emergent features in visual display desing for two types of failure detection tasks", *Human Factors*, 1991, Vol. 33, No. 6, p631 - 651.
- Card, Stuart K., Robertson, George G., and Mackinlay, Jock D., "The Information Visualizer: An information workspace", *Proceedings of CHI '91 Conference, Reaching through Technology*, ACM Press, 1991, p 181 - 188.
- Carliner, Saul, "Elements of editorial style for computer-delivered information", *IEEE Transactions on Professional Communication*, Mar 1990, Vol. 33, No. 1, p 38 - 45.
- Coll, R.A., and Coll J. H., "Tables and Graphs: A classification scheme for data presentation format variables and a framework for research in this area", *Information Processing Management*, 1993, Vol. 29, No. 6, p745-750.
- Coll, Richard A.; Coll, Joan H.; and Thakur, Ganesh, "Graphs and Tables: A four factor experiment", *Communications of the ACM*, April 1994, Vol. 37, No. 4, p77-86.
- Command System, Inc., *M/ARM COMMAND OPERATIONS Support System Product Information package*, Fort Wayne, Indiana, 1992.
- Coury, Bruce G., and Boulette, Margery D., "Time stress and the processing of visual displays", *Human Factors*, 1992, Vol. 34, No. 6, p 707 - 725.
- Dillon, Andrew, "Reading from paper versus screens: A critical review of the literature", *Ergonomics*, 1992, Vol. 35, No. 10, p 1297 - 1326.

- Frey, Paul E.; Rouse, William B.; and Garris, Rosemary D., "Big graphics and little screens: Designing graphical displays for maintenance tasks", *IEEE Transactions on Systems, Man, and Cybernetics*, January/February 1992, Vol. 22, No. 1, p 10 - 20.
- Garland, Ken, "Stop footling around", *Design*, December 1992, p 11 - 13.
- Geiselman, R. Edward; Landee-Thomson, Betty; and Samet, Michael G., "A selective call-up system for managing tactical information on graphic displays", *IEEE Transactions on Systems, Man, and Cybernetics*, Nov/Dec 1986, Vol SMC-16, No. 6, p901 - 908.
- Girill, R.T., "The principles of visual rhetoric and the rhetoric of visual principles", *Journal of Computer Documentation*, Nov. 1991, Vol. 15, No. 3, p 17 - 26.
- Harris, R. Allen, "Linguistic Guidelines for Graphic Interfaces", *IEEE Transactions on Professional Communication*, Mar 1990, Vol. 33, No. 1, p 46 - 53.
- Hoadley, Ellen D., "Investigating the effects of color", *Communications of the ACM*, February 1990, Vol. 33, No. 2, p 120 - 125.
- Horton, William, "Overcoming chromophobia: A guide to the confident and appropriate use of color", *IEEE Transactions on Professional Communication*, Sept. 1991, Vol. 34, No. 3, p 160 - 171.
- Horton, William, "Visual rhetoric for On-line documents", *IEEE Transactions on Professional Communication*, Sept 1990, Vol. 33, No. 3, p 108 - 114.
- Horton, William, *Illustrating Computer Documentation: The art of presenting information graphically on paper and on-line*, John Wiley & Sons, Inc., 1991.
- Jungmeister, Walter-Alexander, and Turo, David, "Adapting Treemaps to stock portfolio visualization", CAR-TR-648, CS-TR-2996, SRC-TR-92-120, Sept. 1992, Human-Computer Interaction Laboratory, Institute for Systems Research, University of Maryland.
- Mackinlay, Jock D., Robertson, George G., and Card, Stuart K., "The Perspective Wall: Detail and context smoothly integrated", *Proceedings of CHI '91 Conference, Reaching through Technology*, ACM Press, 1991, p 173 - 179.
- National Association of Accountants, *Information for Marketing Management*, NAA: NY, July 1971, NAA Research Studies in Management Planning and Control.. Prepared by Booz, Allen & Hamilton Inc., Chicago, for the NAA.
- Orna, Elizabeth and Stevens, Graham, "Information Design and Information Science: A New Alliance?", *Journal of Information Science*, 1991, Vol 17, p 197-208.
- Praetorius, N, and Duncan, K.D., "Flow representation of plant processes for fault diagnosis", *Behaviour & Information Technology*, 1991, Vol. 10, No. 1, p 41-52.
- Rateman, Ben, "Data you can use", *Defense News*, February 8 - 14, 1993, p 30.
- Repede, John F.; Jeffries, Carol J.; and Hubbard, Edward, "ALIAS: A graphical user interface for an ambulance location model", *International Journal of Operations & Production Management*, 1993, Vol. 13, No. 12, p 34 - 46.
- Robertson, George G., Mackinlay, Jock D., and Card, Stuart K., "Cone Trees: Animated 3D visualizations of hierarchical information", *Proceedings of CHI '91 Conference, Reaching through Technology*, ACM Press, 1991, p 189 - 194.
- Sanderson, Penelope M., Haskell, Ian, and Flach, John, M., "The complex role of perceptual organization in visual display design theory", *Ergonomics*, 1992, Vol. 35, No. 10, p 1199 - 1219.
- Scott, Derek, "Visual search in modern human-computer interfaces", *Behaviour & Information Technology*, 1993, Vol.12, No. 3, p 174 -189.
- Smith, Sidney L ., and Mosier, Jane N, *Guidelines for Designing User Interface Software: Designing Data Displays*, MITRE Corp., prepared for Air Force Systems Command, USAF, Hanscom Air Force Base, MA, Report No. ESD-TR-86-278 MTR-10090, August 1986.
- Tufte, Edward R., *Envisioning Information*, Graphics Press: Cheshire, Connecticut, 1990.
- Tufte, Edward R., *The Visual Display of Quantitative Information*, Graphics Press: Cheshire, Connecticut, 1983.
- Tullis, Thomas S., "The formatting of alphanumeric displays: A review and analysis", in *Selected Readings in Human Factors*, Michael Venturino (ed.), The Human Factors Society: CA, 1990, p 371 - 396.
- Turo, David, and Johnson, Brian, "Improving the visualization of hierarchies with Treemaps: Design Issues and Experimentation", *Proceedings of Visualization '92*, Kaufman & Nielsen (eds.) Boston, MA, 1992, p 124 - 131.

- Venturino, Michael, and Post, David L., "Special Issue Preface", *Human Factors*, 1992, Vol. 34, No. 5, p 509 - 511.
- Wickens, Christopher D., *Engineering Psychology and Human Performance*, 2nd ed., HarperCollins Publishers Inc.: NY, 1992.
- Wright, Patricia, "Functional Literacy: Reading and Writing at Work", The Ergonomics Society *The Society's Lecture 1988*, *Ergonomics*, 1988, Vol. 31, No. 3, p 265-290.
- Zelazny, Gene, *Say it with charts: The executive's guide to successful presentations*, Dow Jones-Irwin Publishers: Homewood, Illinois.